



PRO
REAX 1∞1

WELCOME TO REAXING



REAXING is a philosophy of life and an innovative training methodology based on a patented technology.

The innovation of this technology consists in delivering, during the motor gesture, sudden sensory impulses to force and/or encourage the user to react.

From this technology was born a line of exclusive products with greater effectiveness than normal equipment and which thus allows to accelerate the training results.



RESULTS AXELERATOR

REAXING PRODUCTS ARE THE REAL **RESULTS AXELERATOR**

Unlike any traditional product, they simultaneously and way more effectively activate the sensory and the neuro motor systems, with better physical, mental and metabolic results.

REAXING PRESENTS

ONE INFINITY ONE

1∞1

FACE THE **UNPREDICTABLE**, AN EXCLUSIVE EXPERIENCE IN THE ONLY COGNITIVE, PROPRIOCEPTIVE AND NEUROFUNCTIONAL TRAINING STATION IN THE WORLD.





THE FIRST AND ONLY NEUROREACTIVE EQUIPMENT IN THE WORLD THAT ALLOWS YOU TO PERFORM A COGNITIVE, PROPRIOCEPTIVE AND NEUROFUNCTIONAL TRAINING IN JUST 4 SQUARE METERS. 1001 INCLUDES ALL THE REAXING PHILOSOPHY AND TECHNOLOGY. ALL OUR INNOVATIVE AND PATENTED SOLUTIONS IN A SINGLE PROFESSIONAL STATION. 1001 GRANTS UNLIMITED TRAINING COMBINATIONS. A SMART FLOOR AS THE REAX BOARD, A UNIQUE 3D TREADMILL AS THE REAX RUN, A MULTI-PURPOSE STATION FOR FUNCTIONAL TRAINING AND STORAGE PURPOSES, AND FINALLY AN INTELLIGENT LIGHTING SYSTEM AS THE REAX LIGHTS.

FASTER RESULTS FOR USERS

- > INCREASE OF REACTION RATE AND COORDINATION
- > IMPROVEMENT OF PERFORMANCE AND MOTOR SKILLS
- > GREATER MUSCLE ENGAGEMENT AND DEFINITION
- > HIGHER CALORIES BURN AND METABOLIC ACTIVATION
- > BETTER INJURY RECOVER AND FUNCTIONAL RE-EDUCATION

BETTER RESULTS FOR PROFESSIONALS

- > PROFESSIONAL STANDING IMPROVEMENT
- > INCREASE THE CUSTOMERS ACQUISITION AND RETENTION
- > GREATER PROFIT MARGINS AND ADDITIONAL REVENUES
- > ADDED TRAINING VALUE TO A MULTIPLE CLIENTELE TARGET
- > EXCLUSIVITY AND INNOVATION OF THE SERVICES OFFERED

innovation

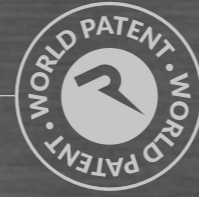

4-IN-ONE TRAINING SOLUTIONS



PROPRIOCEPTIVE TREADMILL

The only treadmill in the world that performs sudden and unpredictable inclinations in all directions while running.

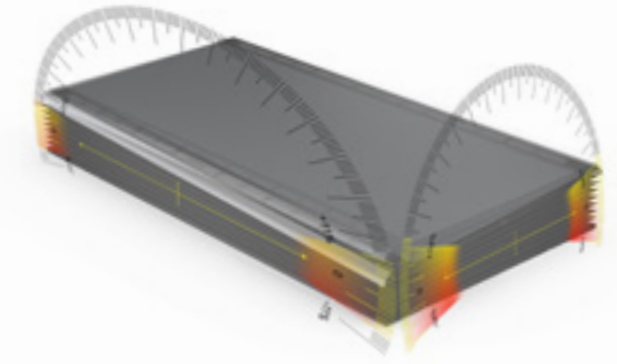

REAX BOARD

The only training board adopting the **Sudden Dynamic Impulse** technology.



COGNITIVE LIGHTS SYSTEM

The first lighting system that merges the cognitive and the reactive training.



FUNCTIONAL EQUIPMENT

A wide range of tools for the smartest trainers. Multiple combinations to create a wide number of workouts.

versatility



EACH CONFIGURATION GRANTS INFINITE TRAINING POSSIBILITIES

IT'S THE ONE AND ONLY NEUROREACTIVE STATION WITH

INFINITE ESERCISES IN **LESS THAN 4 SQM**

CARDIO

TONING

COGNITIVE TRAINING

PROPRIOCEPTIVE TRAINING

NEUROFUNCTIONAL TRAINING



NEUROREACTIVE



NEUROFUNCTIONAL EQUIPMENT WITH EXCLUSIVE TOOLS FOR BOTH SIDES

CUSTOMIZABLE RACK WITH MULTIPLE CONFIGURATIONS FOR STORAGE

PROPRIOCEPTIVE PLATFORM + TREADMILL WITH 3D MOTION PATENTED TECHNOLOGY

3X TRAINING

NEUROREACTIVE TRAINING CAN TRAIN THE THREE MOST IMPORTANT SKILLS IN THE SAME SESSION

PROPRIOCEPTIVE TRAINING

COGNITIVE TRAINING

NEUROFUNCTIONAL TRAINING





WHY IS IT SO EFFECTIVE?

REAX 1001 AMPLIFIES THE EFFICIENCY OF EACH DIFFERENT EXERCISE.

Thanks to the **Sudden Dynamic Impulse** technology, it produces a greater neuro motor efficiency for a real and complete **Neuroreactive Training**, giving better results for health and performance.

TRAINING COMPARISON (EMG)
WITH VS WITHOUT INTERFERENCES

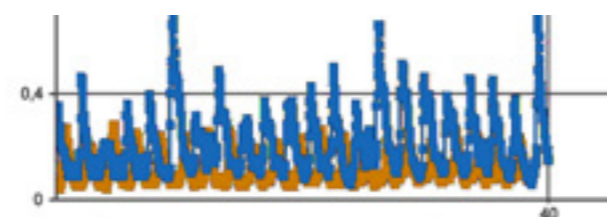

3X EFFECT

YOUR TRAINING PROTOCOL PRODUCES BETTER RESULTS WITH THE **SUDDEN DYNAMIC IMPULSE** TECHNOLOGY

+ SENSORY
ACTIVITY

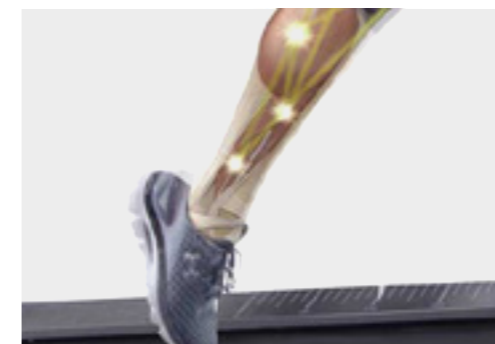

+ NERVOUS
ACTIVITY



+ MUSCLE
ACTIVITY



WHY IS IT SO USEFUL FOR PERFORMANCE?



The products technology applied to a **Neuroreactive Training** enables a faster improvement in terms of physical fitness, reaction ability, execution speed and cognitive skills that are useful for performance purposes and in every different context of life.

- > WIDER RANGE OF EXERCISES AND INCREASEMENT OF THEIR EFFICIENCY
- > HIGH PROPRIOCEPTIVE STIMULATION AND POSTURAL ACTIVATION
- > HIGHER METABOLIC ACTIVATION AND ENERGY EXPENDITURE
- > WIDER INVOLVEMENT OF MUSCLE FIBRES
- > IMPROVED NEURAL EFFICIENCY AND TASK PROCESSING SKILLS
- > COORDINATION - BALANCE IMPROVEMENT AND FALLS PREVENTION
- > IMPROVEMENT IN MOTOR-GESTURE MANAGEMENT AND REACTIVITY
- > IMPROVING FUNCTIONAL RECOVERY

3X RESULT

THE RESULTS OF THE **NEUROREACTIVE TRAINING** HAVE A TRIPLE EFFECT:
BETTER RESULTS AT MENTAL, PHYSICAL AND METABOLIC LEVELS

+ MENTAL EFFICIENCY

FORCES THE USER TO STAY CONNECTED: NO DISTRACTION, HIGH CONCENTRATION, FREQUENT COGNITIVE STIMULI, READY TO REACT!



+ PHYSICAL FUNCTIONALITY

ACTIVATES A GREATER QUANTITY OF MUSCLE FIBERS AND STRENGTHENS JOINTS, THUS RESULTING MORE EFFECTIVE THAN THE TRADITIONAL TRAINING.



+ METABOLIC ACTIVITY

GENERATES GREATER MUSCLE INVOLVEMENT AND THUS INCREASES THE ENERGY CONSUMPTION AND THE METABOLISM, AS NOTICEABLE BY AN ELECTROMYOGRAPHIC EXAM.



WINNING FEATURES



SPACE-SAVING

In 4sqm only you can find a treadmill, a smart proprioceptive floor and a multifunctional and cognitive station (pro-1 version)

UNIQUE

Features, figures and applications with no comparison

ORIGINAL

Innovation, elegance, ergonomic design and an advanced technology in a unique and stylish design

UNPREDICTABLE

Characterized by the Reaxing patented "Sudden Dynamic Impulse" technology

RELIABLE

Made it entirely in Europe with our well-known reputation in detail-care

SILENT

No noises for comfortable workouts, silent even at high speed or interference

USER-FRIENDLY

Easy software to use with an appealing simple-to-use interface

15" HIGH DEFINITION TOUCH SCREEN



On the large display you can watch exercise tutorials to manage your ideal workout, receiving all the information needed.

TOP QUALITY MATERIALS



The best materials and technology can be found in our Reax 1001. Every detail meets the highest quality standards.

DESIGNED FOR PROFESSIONALS



The marks on the training surface allow the user to have a better perception of the right starting position for the exercise.

BEST MOVEMENT EXPERIENCE



While running or walking, both the 72 cm wide belt and the shock absorbing system ensure the highest quality experience.

REAX 1001 PRO2

SPECIAL VERSION WITH CUSTOMIZABLE RACK AND WITH MULTIPLE CONFIGURATIONS FOR TRAINING AND STORAGE

FRAMEWORK

- MOBILE PLATFORM WITH TREADMILL AND MULTIFUNCTIONAL FACILITIES

FINISHES

- EMBOSSED BLACK MAT + SHINY BLACK + CHROMED SHINY BLACK DETAILS

CONSOLE

- 15" TOUCH SCREEN WITH 5 DEDICATED APPS
- OPTIONAL TABLET FOR REMOTE CONTROL

METHODS OF USE

- PROPRIOCEPTIVE REAX RUN
- PROPRIOCEPTIVE REAX BOARD
- NEUROFUNCTIONAL STATION
- REAX TIMER



CONFIGURATION EXAMPLES

1001 CAN COME IN MANY DIFFERENT CONFIGURATIONS TO PERFECTLY FIT YOUR NEEDS. A WIDE RANGE OF ACCESSORIES FOR TRAINING AND STORAGE PURPOSES ARE AVAILABLE.

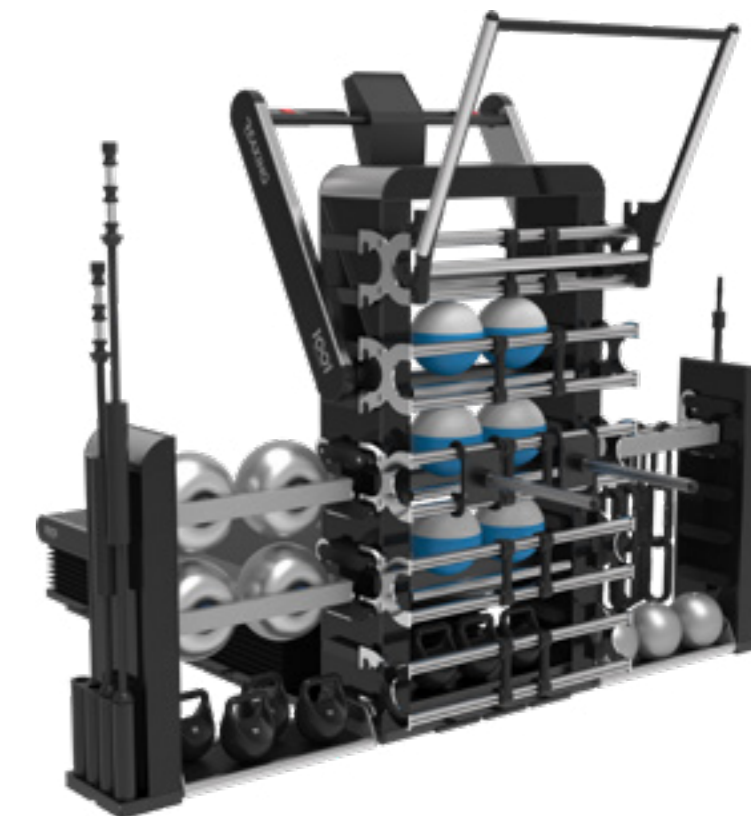

ENDLESS COMBINATIONS

A WIDE RANGE OF TOOLS AVAILABLE TO ENRICH YOUR 1001 STATION

RE 5025 REAX LIGHTS PRO2 - ADVANCED 6



RE 1000 TABLET RE 1010 TABLET HOLDER



RE 1009 FLOOR FOR B SIDE

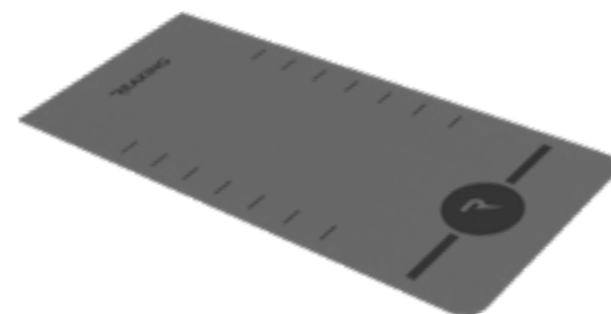

RE 1013 WALLBAR HOUSING / 3 PACK

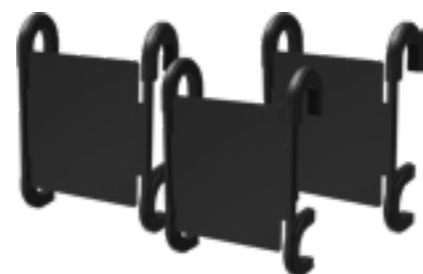

RE 1004 1001 DOUBLE WALLBAR



RE 1008 MULTIFUNCTIONAL SHELF 1



RE 1003 MULTIFUNCTIONAL SHELF 2



RE 1005 MOBILE PARALLELS



RE 1006 MULTIFUNCTIONAL PULL UP



RE 1002 LATERAL STORAGES

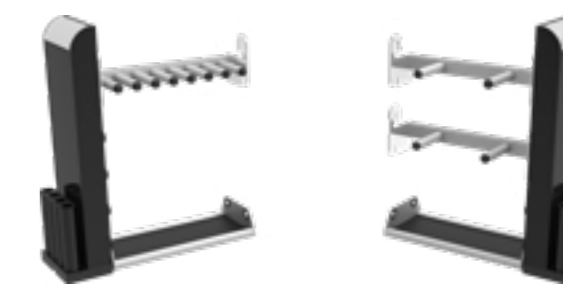



PRO2 SOLUTIONS

- RE 5006 PURE 180
- RE 5007 EXECUTIVE 180
- RE 5008 FUNCTIONAL 180
- RE 5009 ADVANCE 180
- RE 5010 PREMIUM 180
- RE 5011 ADVANCE 360
- RE 5012 PREMIUM 360

RE 5006

REAX **1001** PRO2

PURE 180

1 RE 1007

REAX 1001 - PRO2

OPTIONAL

RE 1000

TABLET



RE 5007

REAX 1001 PRO2

EXECUTIVE 180

- 1 RE 1007
- 4 RE 1008

REAX 1001 - PRO2
MULTIFUNCTIONAL SHELF 1

OPTIONAL

RE 1000

TABLET



RE 5008

REAX 1001 PRO2

FUNCTIONAL 180

- 1 RE 1007
- 4 RE 1004
- 1 RE 1005
- 1 RE 1006

REAX 1001 - PRO2
1001 DOUBLE WALLBAR
MOBILE PARALLELS
MULTIFUNCTIONAL PULL UP

OPTIONAL

- RE 1000
- RE 1010
- RE 5025
- RE 1013
- RE 1173
- RE 1174

TABLET
TABLET HOLDER
REAX LIGHTS PRO2 - ADVANCED 6
WALLBAR HOUSING - 3 PACK
REAX APPAREL S/M
REAX APPAREL L/XL



RE 5009

REAX 1001 PRO2

ADVANCE 180

- 1 RE 1007
- 4 RE 1004
- 1 RE 1005
- 1 RE 1006
- 4 RE 1008

REAX 1001 - PRO2
 1001 DOUBLE WALLBAR
 MOBILE PARALLELS
 MULTIFUNCTIONAL PULL UP
 MULTIFUNCTIONAL SHELF 1

OPTIONAL

- RE 1000
- RE 1010
- RE 5025
- RE 1013
- RE 1173
- RE 1174

TABLET
 TABLET HOLDER
 REAX LIGHTS PRO2 - ADVANCED 6
 WALLBAR HOUSING - 3 PACK
 REAX APPAREL S/M
 REAX APPAREL L/XL



RE 5010

REAX 1001 PRO2

PREMIUM 180

- 1 RE 1007
- 4 RE 1004
- 1 RE 1005
- 1 RE 1006
- 4 RE 1008
- 1 RE 1002

REAX 1001 - PRO2
 1001 DOUBLE WALLBAR
 MOBILE PARALLELS
 MULTIFUNCTIONAL PULL UP
 MULTIFUNCTIONAL SHELF 1
 LATERAL STORAGES

OPTIONAL

- RE 1000
- RE 1010
- RE 5025
- RE 1013
- RE 1173
- RE 1174

TABLET
 TABLET HOLDER
 REAX LIGHTS PRO2 - ADVANCED 6
 WALLBAR HOUSING - 3 PACK
 REAX APPAREL S/M
 REAX APPAREL L/XL



RE 5011

REAX 1001 PRO2

ADVANCE 360

- 1 RE 1007
 - 5 RE 1004
 - 1 RE 1005
 - 1 RE 1006
 - 4 RE 1008
- REAX 1001 - PRO2
1001 DOUBLE WALLBAR
MOBILE PARALLELS
MULTIFUNCTIONAL PULL UP
MULTIFUNCTIONAL SHELF 1

OPTIONAL

- RE 1000
 - RE 1010
 - RE 5025
 - RE 1013
 - RE 1009
 - RE 1173
 - RE 1174
- TABLET
TABLET HOLDER
REAX LIGHTS PRO2 - ADVANCE 6
WALLBAR HOUSING - 3 PACK
FLOOR FOR B SIDE
REAX APPAREL S/M
REAX APPAREL L/XL



A SIDE

RE 5011

REAX 1001 PRO2

ADVANCE 360



B SIDE

RE 5012

REAX 1001 PRO2

PREMIUM 360

- 1 RE 1007
 - 5 RE 1004
 - 1 RE 1005
 - 1 RE 1006
 - 4 RE 1008
 - 1 RE 1002
- REAX 1001 - PRO2
1001 DOUBLE WALLBAR
MOBILE PARALLELS
MULTIFUNCTIONAL PULL UP
MULTIFUNCTIONAL SHELF 1
LATERAL STORAGES

OPTIONAL

- RE 1000
 - RE 1010
 - RE 5025
 - RE 1013
 - RE 1009
 - RE 1173
 - RE 1174
- TABLET
TABLET HOLDER
REAX LIGHTS PRO2 - ADVANCE 6
WALLBAR HOUSING - 3 PACK
FLOOR FOR B SIDE
REAX APPAREL S/M
REAX APPAREL L/XL



A SIDE

RE 5012

REAX 1001 PRO2

PREMIUM 360



B SIDE

SMART & INTUITIVE

THE MOST ADVANCED AND INTUITIVE TECHNOLOGY OFFER FOR TRAINING AND MONITORING PHYSICAL AND MENTAL PERFORMANCES, EXTENDING THE FIELD OF APPLICATION AND CREATING NEW AND MORE PROFITABLE BUSINESS AND PROFESSIONAL OPPORTUNITIES.



VARIOUS TRAINING PROGRAMS

QUICK START

MANUAL

TUTORIAL VIDEO

WARM UP

BALANCE

COORDINATION

FLEXIBILITY

AGILITY

STRENGTH

FAT LOSS

GOAL DISTANCE

GOAL TIME

GOAL CALORIE

DOWN HILL

UP HILL

HIKING

FARTLEK

HIIT

TRIAL

CHR

CADENCE

PACE

REMOTE & LIVE CONTROL

REAX TABLET

AN OPTIONAL TABLET INTEGRATED WITH A DEDICATED APP ALLOWS THE USER TO PROGRAM AND CONTROL EACH PHASE OF THE WORKOUT. IT IS ALSO POSSIBLE FOR THE TRAINER TO GIVE AND MODIFY THE IMPULSES DURING THE EXERCISE.



LEADING THE GAME

LIVE
MODE

THE SPECIAL LIVE PROGRAM (AVAILABLE ONLY ON TABLET) ALLOWS THE TRAINER TO KEEP CONTROL OF THE INTERFERENCES.

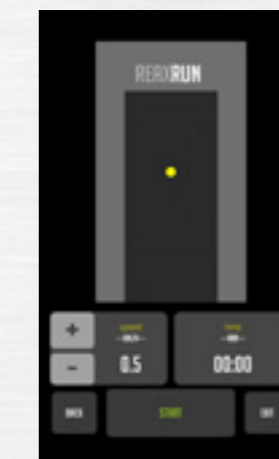

PRO2 INTERFACES

4 DIFFERENT POSSIBILITIES OF USE, SELECTABLE FROM THE CONSOLE HOMEPAGE: REAX RUN FOR RUNNING, REAX BOARD FOR BODYWEIGHT EXERCISES, REAX FUNCTIONAL FOR NEUROMUSCULAR TRAINING AND REAX TIMER TO BETTER MANAGE YOUR WORKOUTS.

Home



Reax Board

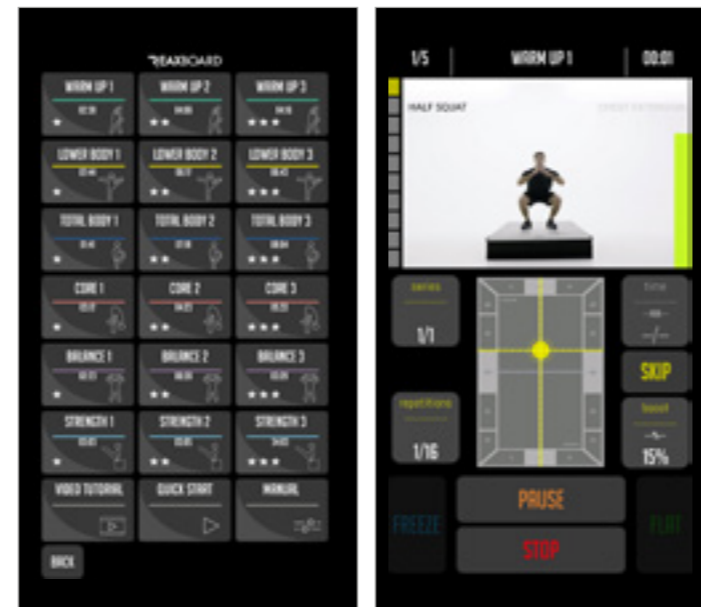

Reax Run

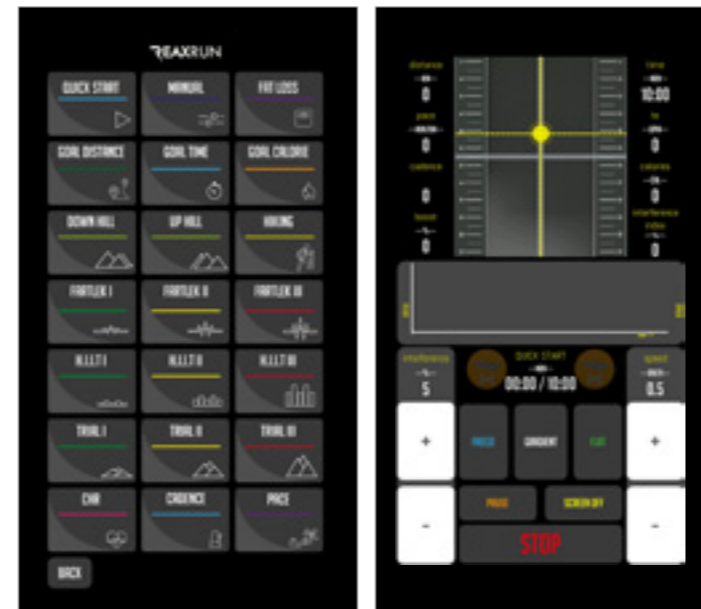

Reax Timer

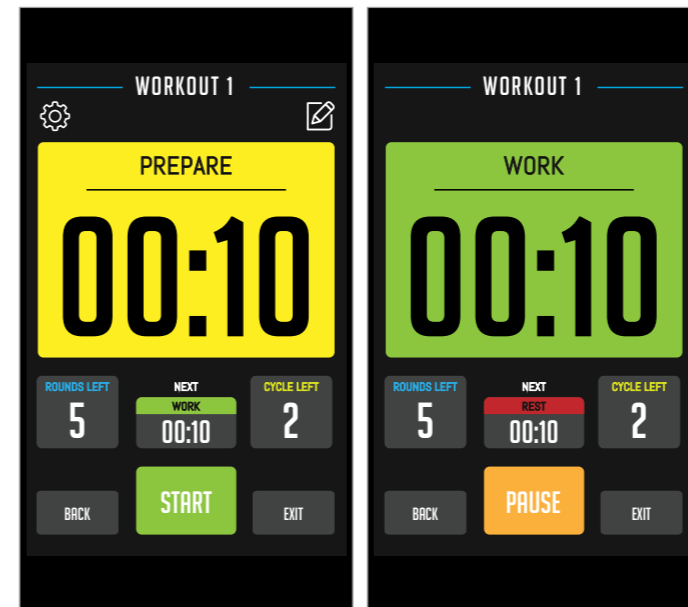

Reax Functional

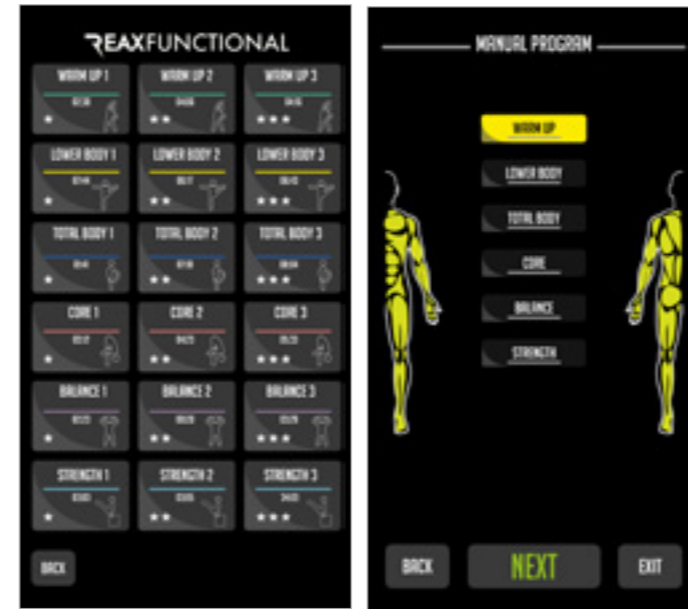

LIGHTING SYSTEM

OPTIONAL

REAX 1001 PRO2 VERSION CAN BE EQUIPPED WITH THE REAX LIGHTS PRO SYSTEM CONTROLLED BY A DEDICATED REAX TABLET.



AREA SET-UP

ONE-INFINITY-ONE IS VERSATILE AND CAN FIT IN ANY SPACE, CREATING REAL TRAINING AREAS WHERE USERS CAN PERFORM A SAFE AND EFFECTIVE WORKOUT.

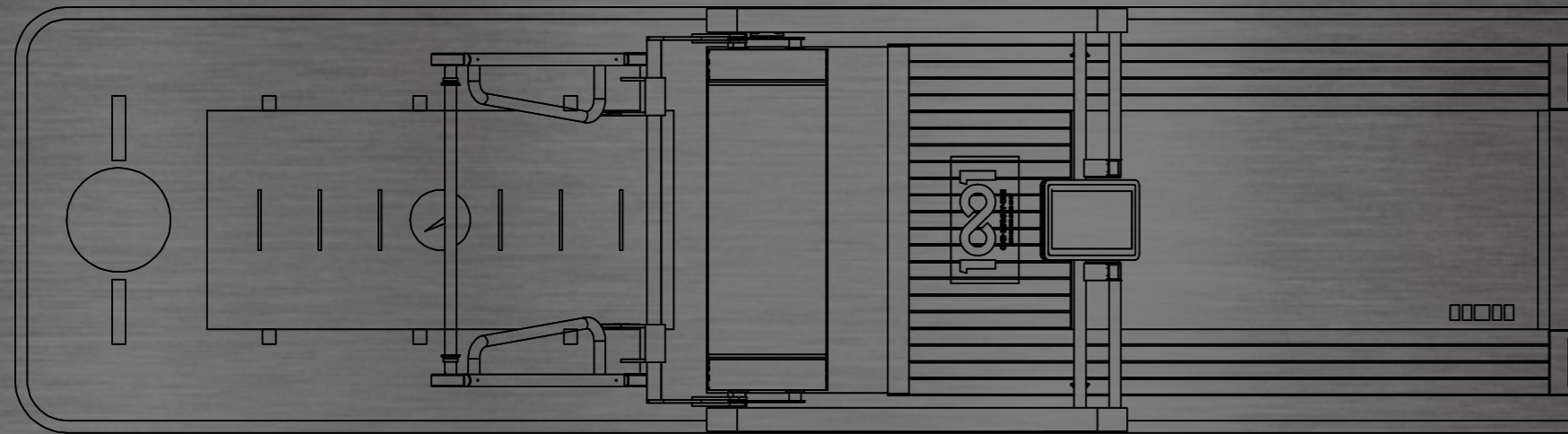

180° SPACE

WALL MOUNTED

TO TRAIN UP TO 5 PEOPLE
IN THE SAME TIME



360° SPACE

NO WALL MOUNTED

TO TRAIN UP TO 8 PEOPLE
IN THE SAME TIME



180° SOLUTIONS

MINIMUM
PRODUCT
SPACE **3,4** SQM

WALL MOUNTED (15 cm)
FRONTAL position:
• A side use for training



180° SOLUTIONS

MINIMUM
PRODUCT
SPACE **4,2** SQM

NEAR THE WALL (70 cm)
FRONTAL position:
• A side use for training
• B side use for storage
LATERAL position:
• A side use for training
• B side use for training / storage

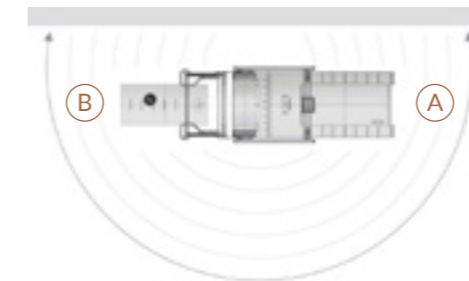
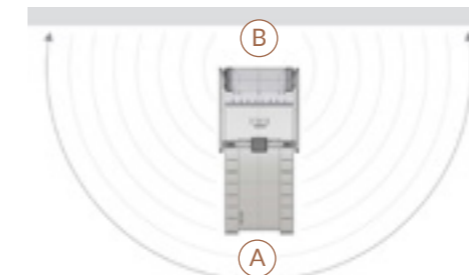

360° SOLUTIONS

MINIMUM
PRODUCT
SPACE **5,7** SQM

NO WALL MOUNTED
1 OR 2 PEOPLE

- A side use for training
- B side use for training / storage



360° SOLUTIONS

MINIMUM
PRODUCT
SPACE FROM **16** SQM

NO WALL MOUNTED
1 OR 2 PEOPLE

- A side use for training
- B side use for training / storage
- C side use for training / storage
- D side use for training / storage

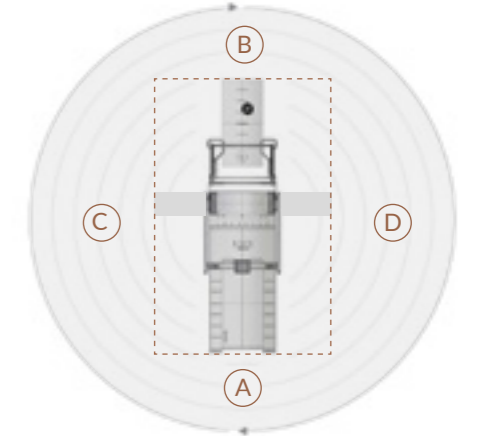

PROFESSIONAL FIELDS

REAX 1001 is the ideal training partner to reach better results in less time, with a superior sensory and motor experience. It is ideal to train effectively multiple users in many fields of use with top specialized activities.

- PROFESSIONAL SPORT AND TRAINING CENTER
- HIGH PERFORMANCE STUDIO
- SPORT REHAB STUDIO
- MEDICAL FITNESS CENTER
- FITNESS & WELLNESS GYM
- HOTEL & RESORT GYM
- HOME & RESIDENCE GYM
- PERSONAL TRAINING STUDIO
- HEALTH & MEDICAL CENTER
- MUNICIPAL / MILITARY GYM



1 HIGH PERFORMANCE

STRENGTH & CONDITIONING



COACHING ADVANTAGES

Several world class coaches and league champions use Reaxing, as they have seen a clear improvement in their clients performances.

2 SPORT REHAB

PREVENTION & REEDUCATION



PHYSIOTHERAPIST ADVANTAGES

In the medical field, Reaxing can be considered as a new frontier for functional recovery: it opens up to various possibilities that might lead to better results.

3 PROFESSIONAL FITNESS

REACTIVATION & TONIFICATION



TRAINER ADVANTAGES

Trainers can improve and develop their professional skills to reach a higher level using Reaxing.

SUGGESTED TRAINING

TRY THE MULTIPLE COMBINATIONS MERGING THE EQUIPMENT AND THE REAX ACCESSORIES. THE REAX 1001 IS THE PERFECT PLACE WHERE CREATIVITY AND PROFESSIONAL KNOWLEDGE FIND THEIR BEST SHAPE.



BLIND TRAINING



REAX 1001 AMPLIFIES THE POTENTIAL OF EVERY SINGLE TOOL, ENHANCING ITS EFFECTIVENESS AND IMPROVING ITS RESULTS.



MED BALL TRAINING



KETTLEBELL TRAINING

BALANCE TRAINING



ELASTIC TRAINING



ONE TO ONE TRAINING

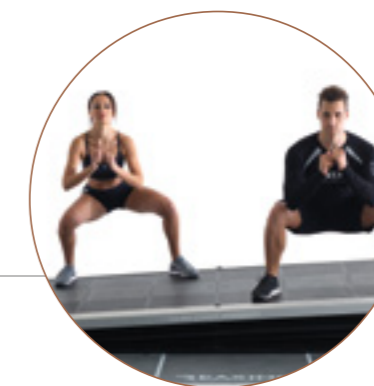

100% ITALIAN STYLE

INNOVATION, ELEGANCE, ERGONOMIC DESIGN
AND ADVANCED TECHNOLOGY IN A STYLISH
AND UNIQUE DESIGN.

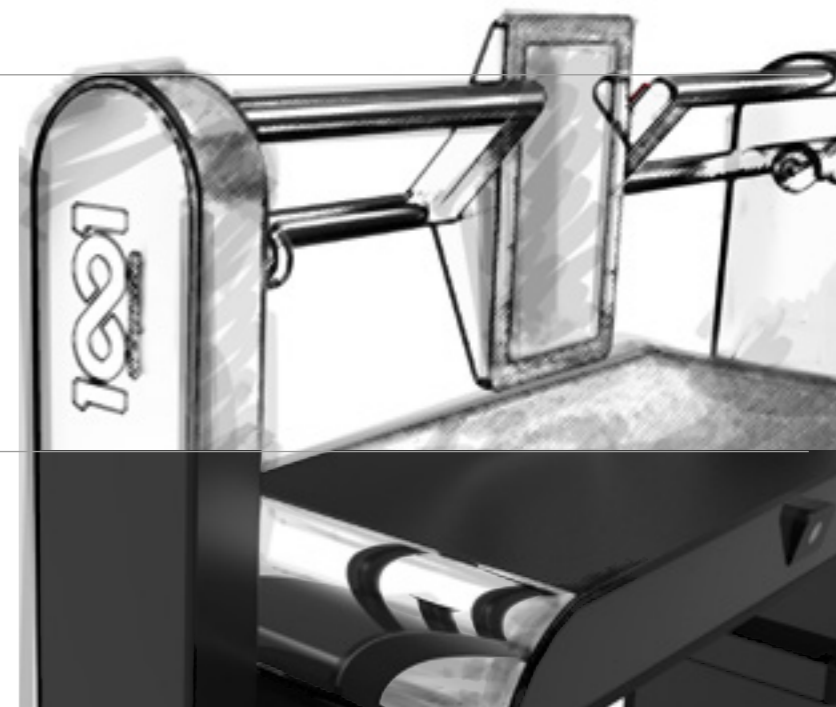
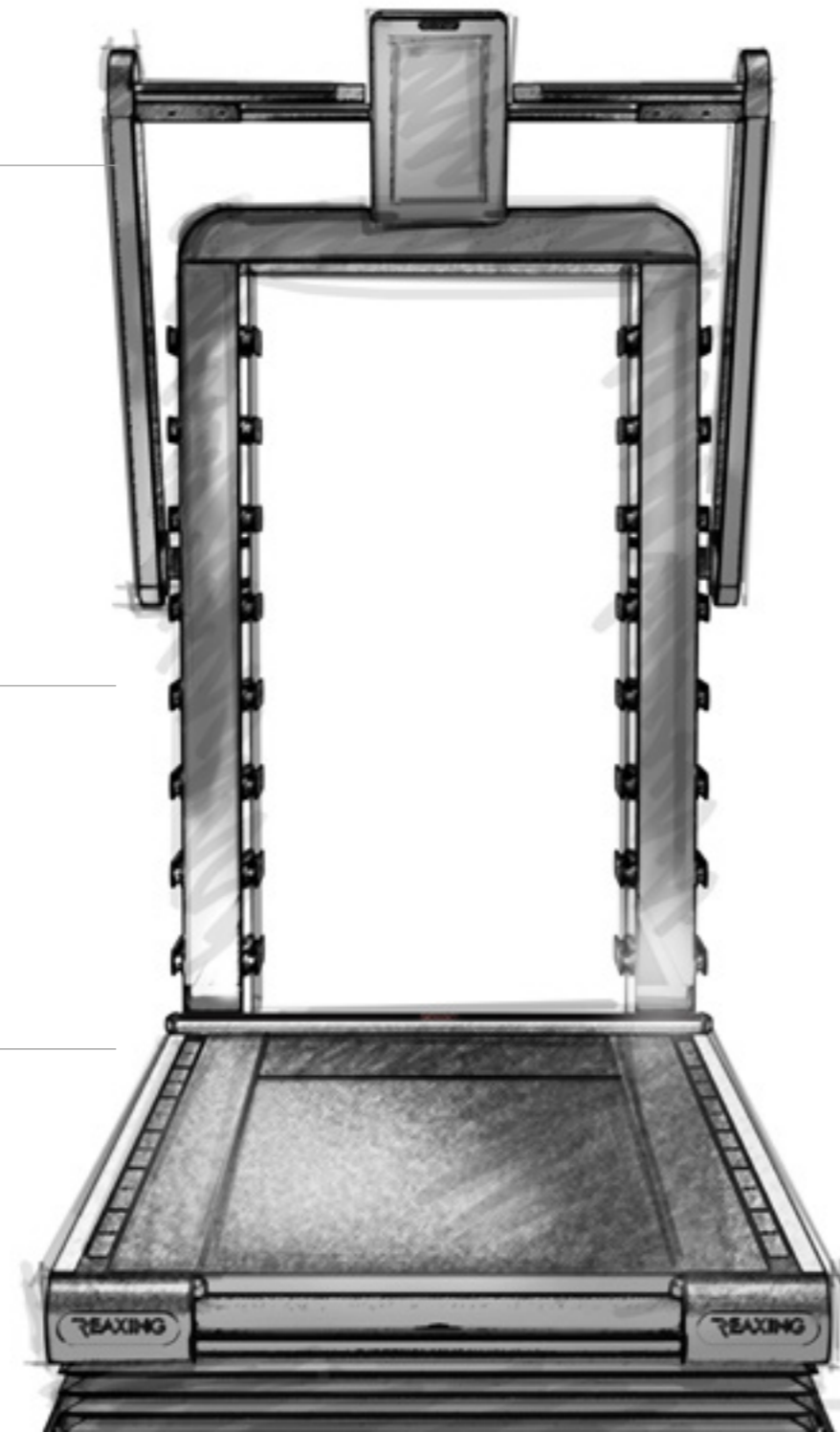
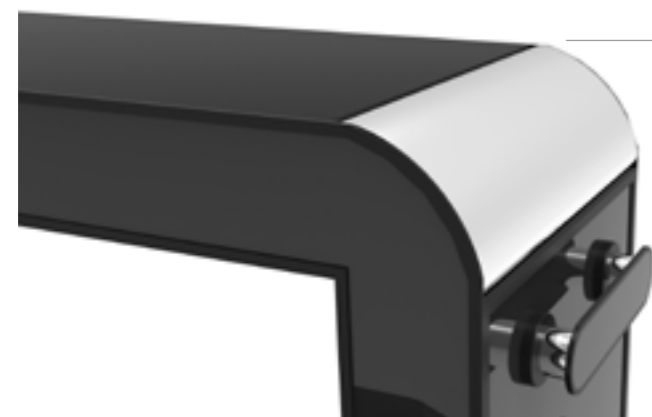

Exclusive offer

An exclusive
offer for
exclusive and
loyal clients



New frontiers

Everything
you need is to
merge the most
innovative and
effective rehab
techniques



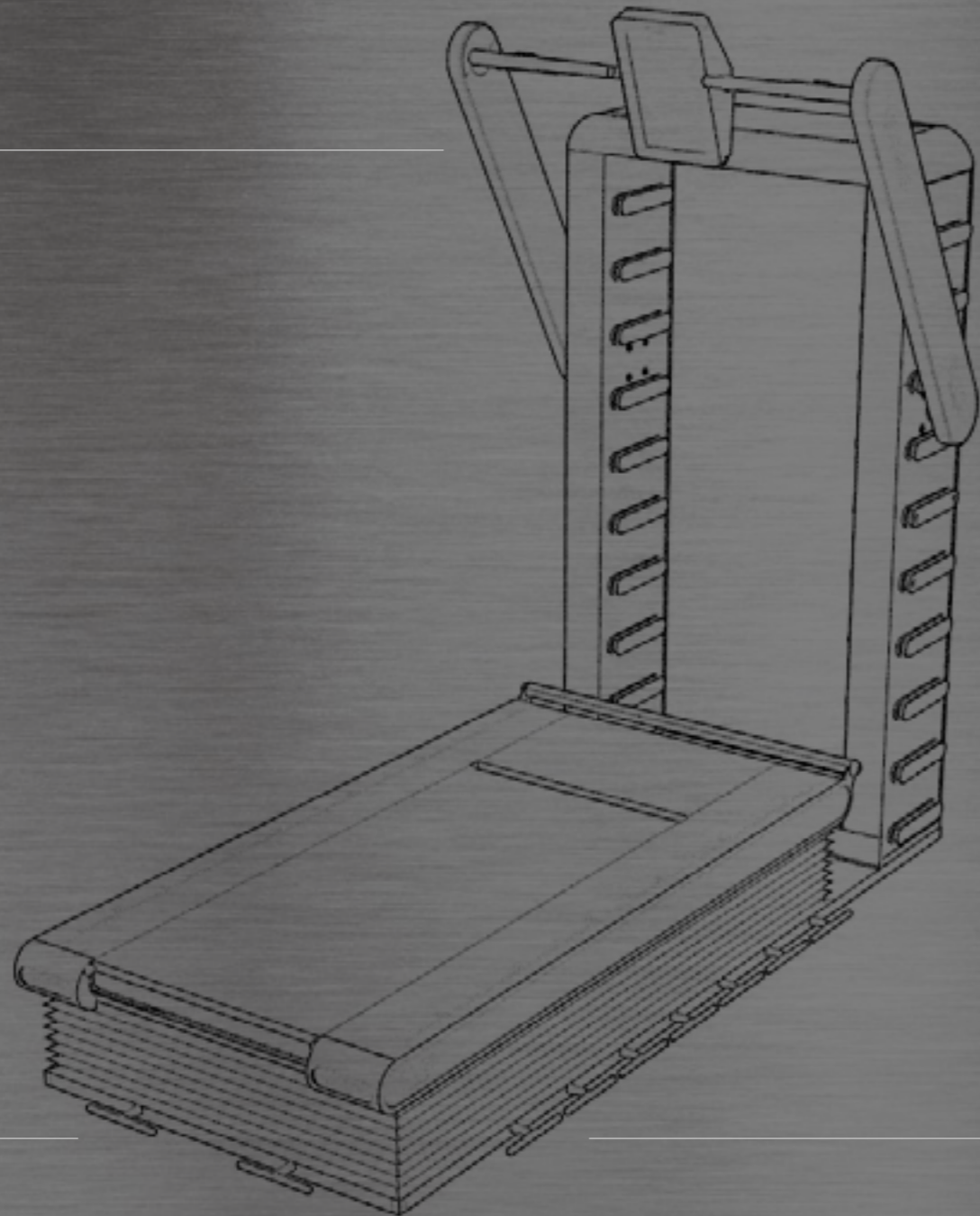

RE 1002

REAX 1001 PRO2

EQUIPMENT SPECIFICATIONS

AUTO STOP	YES
EMERGENCY STOP SYSTEM	YES
ELEVATION SYSTEM	NO
PATENTED MOVEMENT	3D MOTION
BLUETOOTH	NO
HANDLEBAR LENGTH OF USE	48 CM 18,89 IN
ARM ROTATION SYSTEM	YES
ROLLER DIAMETER	12 CM 4,72 IN
MOTOR	2,2 3 HP
MAXIMUM USER WEIGHT	220 KG 485 LB
STEP UP HEIGHT	38 CM 14,96 IN
SPEED RANGE	0,5-25 KM/H
FRONTAL INCLINATION RANGE	+/- 11°
SIDE INCLINATION RANGE	+/- 14°
FRAME COLOR	BLACK
RUNNING SURFACE WIDTH	73 CM 28,74 IN
LIGHTS STATION SYSTEM	NO
MONITOR SIZE	15" LCD - WIDE 16:9

DIMENSION AND WEIGHT

WIDTH	136 CM 53,54 IN
LENGTH	287 CM 112,99 IN
HEIGHT	256 CM 100,78 IN

POWER REQUIREMENTS

INTERNATIONAL 240 VAC	YES
USA AND CANADA 110 VCA	110V-220V
	TRANSFORMER REQUIRED
POWER CABLE LENGTH	200 CM 78,74 IN

REGULATORY

CE	YES
----	-----

CONSOLE FEATURES

CONSOLE TYPE	TOUCH SCREEN
OPERATING SYSTEM	ANDROID
QUICKSTART	YES
CONSOLE LANGUAGE (S)	ENGLISH, RUSSIAN
NUMBER OF PROGRAMS	4

HEART RATE MONITORING

TELEMETRY	POLAR H7, H10, POLAR T31 (NOT CODED)
-----------	--

WORLDWIDE SUPPORT

MARKETING & TRAINING

REAXING fully supports its partners and their activities to use REAX 1001 in the most productive way. Qualified professionals and trainers have created and developed a wide range of programs, based on the REAXING method and suitable for any professional need.

ON SITE & ON LINE TRAINING

A SPECIFIC TRAINING COURSE AND A DEDICATED VIDEO SECTION INCLUDING TUTORIALS HAVE BEEN CREATED TO HELP PROFESSIONALS EMBRACE THE REAXING METHOD.

EXPERTS SUPPORT

OUR EXPERTS ARE AT YOUR DISPOSAL TO ASSIST YOU WITH ANY TECHNICAL, AND COMMERCIAL REQUEST.

MARKETING

WE ASSIST OUR PARTNERS WITH A SPECIFIC RANGE OF COMMERCIAL AND MARKETING MATERIALS TO ACHIEVE HIGHER REVENUES AND CUSTOMER RETENTION.

CONNECTED ALL OVER THE WORLD

OUR SHOWROOMS ARE AT YOUR DISPOSAL: DEDICATED SPACES FOR OUR PARTNERS, WHERE YOU CAN HAVE A CLEAR VISUAL AND VIRTUAL EXPERIENCE OF OUR PRODUCTS, BUT ALSO THE POSSIBILITY TO VIRTUALLY EXHIBIT OUR PRODUCTS TO YOUR OWN CLIENTS. HIGH QUALITY VIDEOS AND SOUND TO ACHIEVE THE BEST RESULTS FOR OUR CLIENTS: COME AND DISCOVER THE INNOVATIVE WORLD OF REAXING.



REAXING[®]

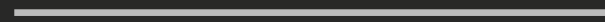

r e a x i n g . c o m